

Sartorius CUBIS® Precision Balance Model MSU6202S-000-DO



Specifications

Weighing capacity	6200 g
Readability	10 mg.
Pan size	206 x 206 mm / 8.1 x 8.1 in.
Response time (avg.)	1.5 sec.
Repeatability	≤± 7 mg
Linearity	≤± 20 mg
Corner Load	20 mg. (5,000 g.)

Standard Features:

- MSU Display features a high-resolution black and white 5.7" graphical display with soft key operation. Display is tiltable and control unit detachable.
- Q-Level – The first balance in its class with automatic leveling.
- Q-Pan – Off Center load compensation reduces off-center loading errors, enables Cubis to be designed with an extra-large weighing pan.
- Q-Comm – provides maximum connectivity. Three standard interface ports (RS-232, USB, Ethernet).
- Q-Guide – novel, wizard-supported User/Task Management for easiest operation – even when the most complex weighing tasks need to be performed.
- Advanced Pharma Compliance makes Cubis ideal for use in regulated areas. Alert messages and reminder functions with user-definable action hierarchy for leveling, minimum sample weight, calibration and adjustment. Fully automatic calibration and adjustment with isoCAL, GLP-compliant, user configurable printouts,
- All Data, such as user base data or tasks can easily be transferred by SD card from one Cubis to another.
- Applications include mass unit conversion, SQmin function, isoCAL function, Density determination, statistics, calculation, averaging, formulation, percent weighing, time-controlled functions, totalizing, second tare memory, counting and over/under checkweighing.

Sartorius Corporation
5 Orville Drive
Bohemia, NY 11716
Toll Free: (800) 635-2906
☎ (631) 254-4249
Fax (631) 254-4252

For 3D Demonstration Go To:
www.Sartorius.com/Cubis

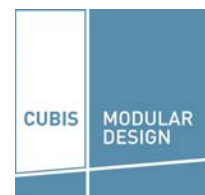

Sartorius CUBIS® Series

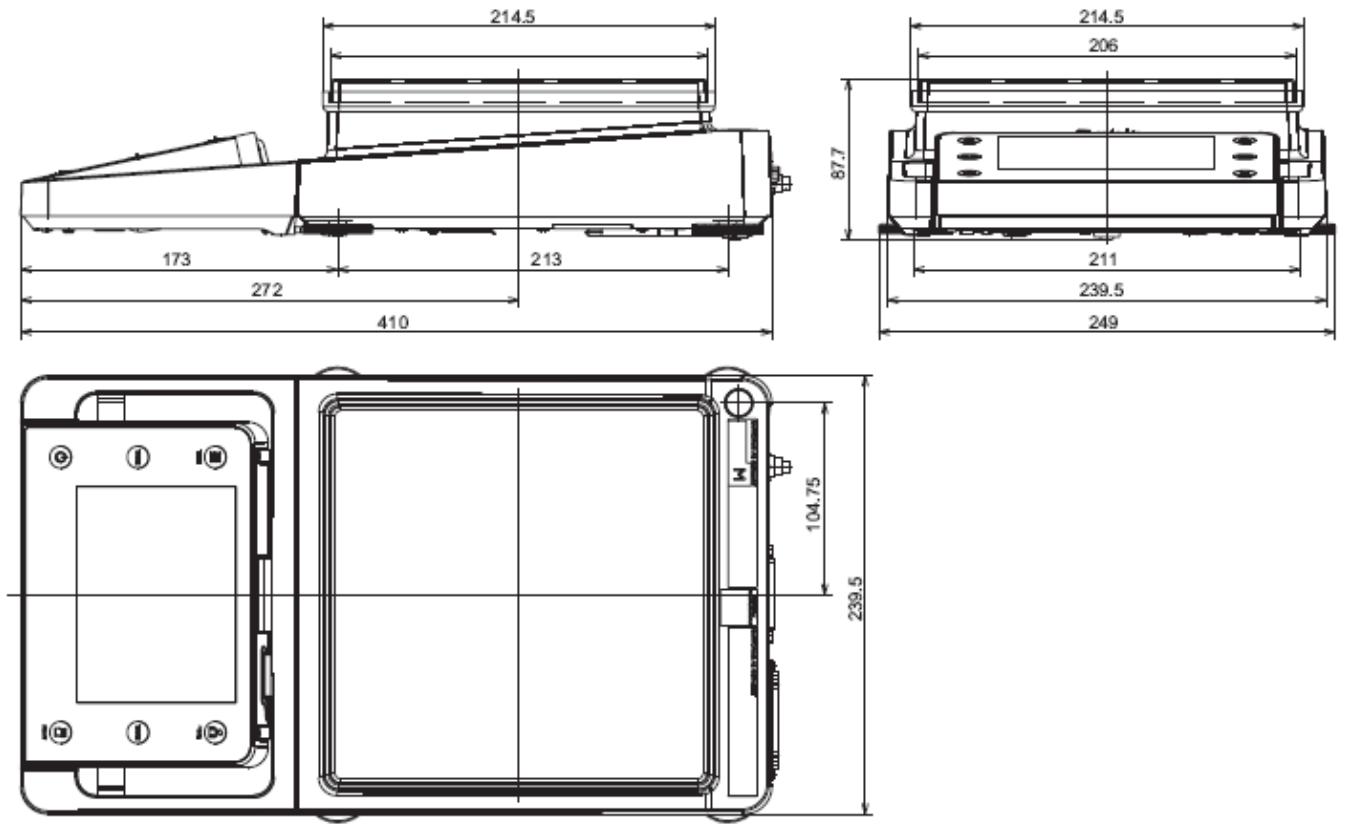

- Options:
- IR = Additional RS232, 25 pin connection
 - IB = Bluetooth wireless interface
 - IP = Additional RS232C, 9 pin connection with PS2 port

Sartorius Corporation
5 Orville Drive
Bohemia, NY 11716
Toll Free: (800) 635-2906
☎ (631) 254-4249
Fax (631) 254-4252

For 3D Demonstration Go To:
www.Sartorius.com/Cubis

